

INSTALLATION

1. Measure the width of the opening of where you intend to install the gate. For openings over 82cm (32") select the appropriate Gate Extension(s). Some examples are shown below. Range of Gate Extensions and dimensions listed.

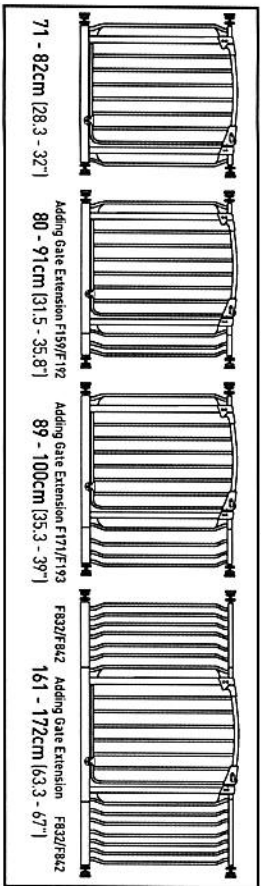

2. To use with Gate Extension Frames: First insert the Extension Pins into the holes on the outside of the Gate Frame.

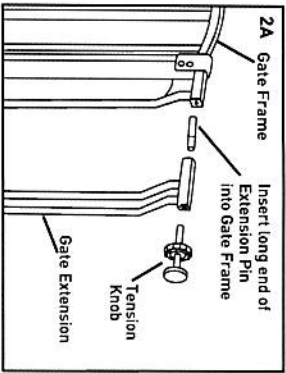

Note:
 The long end of the pins fit into the Gate Frame and the short ends fit into the longer protrusion of Extension Frame (follow diagram).

| Gate Extensions | |
|------------------------|--------------|
| F159/F192 | 9cm (3.5") |
| F171/F193 | 18cm (7") |
| F172/F194 | 27cm (10.5") |
| *F831/F841 | 36cm (14") |
| *F832/F842 | 45cm (17.5") |
| *F833/F843 | 54cm (21") |
| *F834/F844 | 63cm (24.5") |
| *F835/F845 | 100cm (39") |
| *Wider Gate Extensions | |

3. Place the gate in the opening so that the bottom of the Gate Frame is completely flat on the floor (3A), and it is perpendicular to the openings and the floor (3B). Then fasten the Mounting Cups to the wall (3C) with screws or double-sided adhesive tape. Note: Ensure that they are aligned vertically, so that the Mounting Cups at the top are directly above the ones at the bottom.

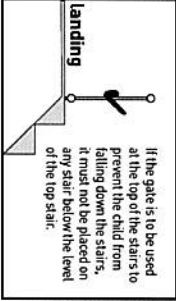
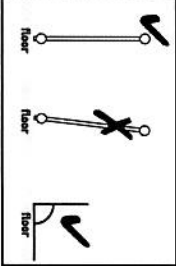
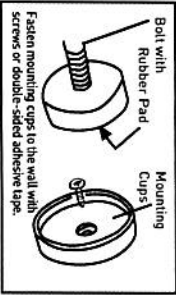
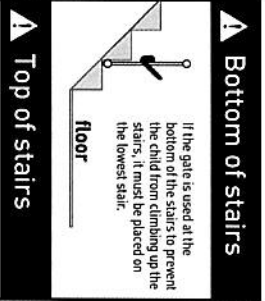
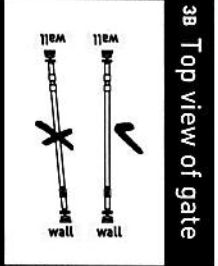
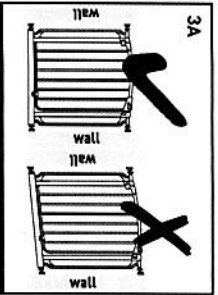

F160/F190

4. Centre the gate in the opening. The distance from the Tension Knobs positioned at the bottom of the gate, to the walls, should be equal (4A).

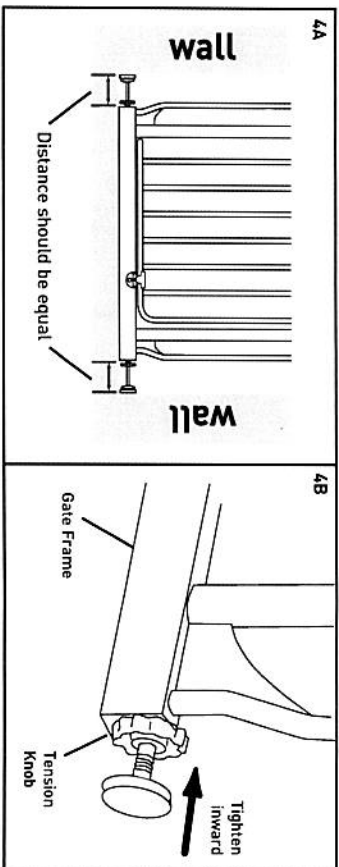

5. Tighten both of the Tension Knobs by turning them clockwise at the same time (5A and 5B). Note: make sure that the bottom of the Gate Frame remains completely flat on the floor. Ensure gate is securely fastened at both top and bottom.

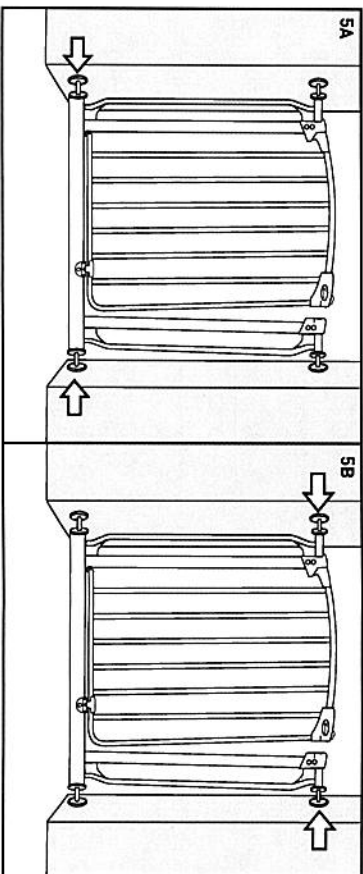

6. Tighten the Tension Knobs until the 2 Indicator Lines, located on the Upper Locking Set and on the Right Upper Corner, align horizontally (6). Keep 1mm (0.04") gap between Upper Locking Set and Upper Right Corner (6).

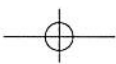
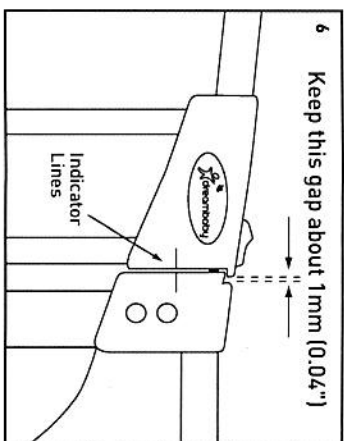

OPERATION

7. To open the gate: Slide the Gate Release Switch (7A). Lift the Gate Panel upward (7B). Gate swings open in both directions (7C).

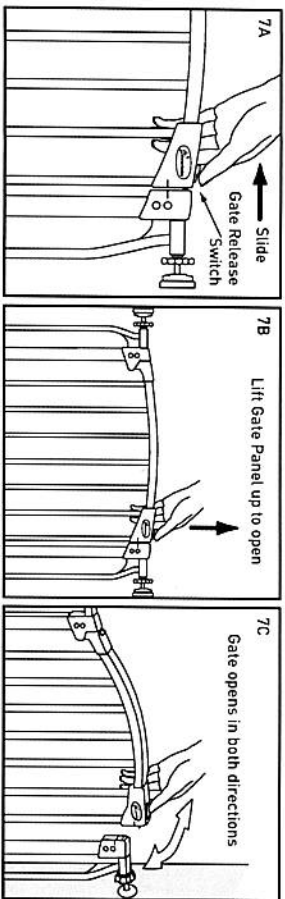

8. To close the gate: Release the Gate and it will swing closed automatically. Try this action several times and make sure:
- The Upper Lock Rod and the latch of the Switch are completely latched within the Lock Holder at Right Upper Corner (8A).
 - The Lower Lock Rod of the Gate Panel fits securely into the Lock Holder of Gate Frame (8B).
 - Tension Bolts and Mounting Cups are securely tightened on the wall.

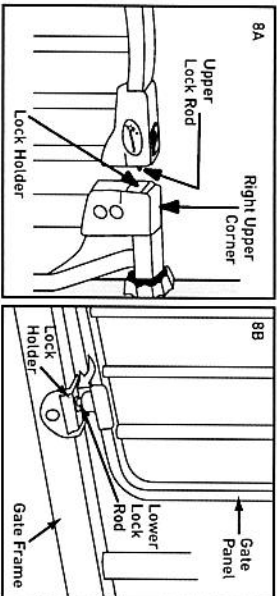

MAINTENANCE & CARE

- Gate must be fitted according to instructions, to ensure it works correctly.
- Regularly check gate to ensure it is fitted properly and securely. Adjust as required.
- Regularly check tension knobs and rubber pads to make sure the gate is securely in place.
- Do not use the safety gate if any components are damaged or missing.
- To clean, wipe surface with a damp cloth or sponge using mild detergent and warm water. Never clean with abrasive, ammonia based bleach based or spirit type cleaners.
- If the gate does not stay in position or does not swing closed properly, the gate may not be installed properly. Remove and re-install gate, make sure the gate is installed vertically.
- Indicator Lines must be correctly aligned. Keep 1mm (0.04") gap.
- Any additional and replacement parts should be obtained from Tee-Zed Products.

CONTACT DETAILS

TEE-ZED PRODUCTS PTY LIMITED OR TEE-ZED PRODUCTS (N.Z.) LIMITED ACCEPTS NO RESPONSIBILITY FOR ANY LOSS OR DAMAGE SUFFERED BY ANY PERSON AS A RESULT OF THE USE OR MISUSE OF THESE GOODS. IN THE CASE OF ANY DEFECT IN THE GOODS, TEE-ZED'S LIABILITY SHALL BE LIMITED SOLELY TO REPLACEMENT OF THE DEFECTIVE GOODS.

Dream Baby products by

Tee-Zed Products Pty Ltd, PO Box 2022,
Bondi Junction NSW 1555
Australia Ph: (02) 9386 4000

Tee-Zed Products (N.Z.) Ltd PO Box 64013,
Botany Town Centre, Auckland
New Zealand Ph: (09) 274 8788

info@tee-zed.com.au
www.dreambaby.com.au
www.dream-babylog.com

Made in China
©2009 Tee-Zed Products Pty Ltd

growing safely

INSTRUCTIONS

Easy Close Gate

F160
F190

Important: Keep instructions for future reference
Read INSTRUCTIONS thoroughly before assembling and installing gate.

Complies with Standards: BS EN11930:2000

WARNING

- To prevent serious injury or death, securely install gate and use according to manufacturer's instructions.
- This product is intended for use with children 6 - 24 months.
- Never leave child unattended. This product may not prevent all accidents.
- This product is not to be used with a child able to climb over or dislodge/open the gate.
- WARNING: Incorrect fitting or positioning of this safety barrier can be dangerous.
- The surfaces that the safety gate is to be fixed to must be suitable for the purpose and must be structurally sound.
- NOTE: Do not use this gate if it can't be installed to walls, door frames or posts - tightly and flatly.
- This safety gate shall not be fitted across window openings and the like.
- Never use without Mounting Cups.
- Securely install and operate the gate according to instructions to help prevent accidental injury.
- Do not use the safety gate if any components are damaged or missing.
- Install this gate away from heaters and other sources of heat.
- This gate is intended for indoor use and is not to be exposed to outdoor elements.
- Gate is not meant to replace proper adult supervision.
- If the gate is used at the bottom of the stairs to prevent the child from climbing up the stairs, it must be placed on the lowest stair.
- If the gate is to be used at the top of the stairs to prevent the child from falling down the stairs, it must not be placed on any stair below the level of the top stair.

WARNING – The position of the safety barrier in relation to the stairs may have an adverse effect on your child's safety.

WARNING: Incorrect fitting or positioning of this safety barrier can be dangerous.

PARTS LIST

- 1 Gate Panel
- 2 Upper Locking Set
- 3 Release Switch with Latch
- 4 Right Upper Corner
- 5 Tension Knobs
- 6 Bolts with Rubber Pads
- 7 Mounting Cups
- 8 Gate Frame
- 9 Lower Locking Set

